	<p>1. Press the cover release button and then open the front cover of the printer.</p>
	<p>2. Pull out the drum assembly (drum unit with toner cartridge).</p>
	<p>3. Push down the blue lock lever and take the toner cartridge out of the drum unit assembly.</p>
	<p>4. Unpack the new toner cartridge. Hold the cartridge level with both hands and gently rock it from side to side five or six times to spread the toner evenly inside the cartridge.</p>

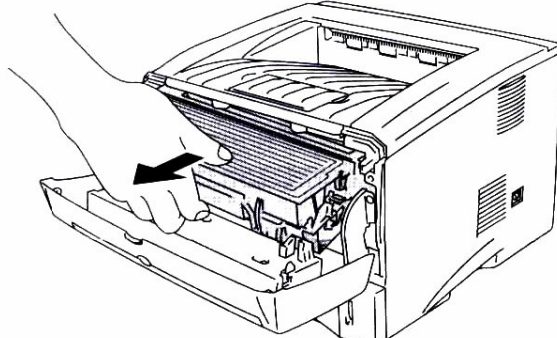

5. Pull off the protective cover

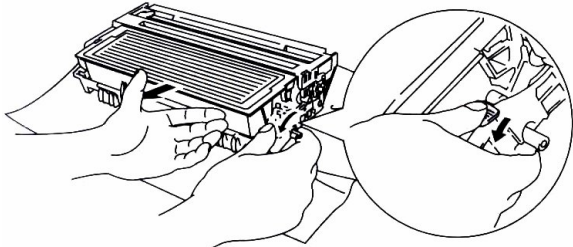

6. Put the new toner cartridge firmly into the drum unit until you hear it lock into place. If you put it in properly, the lock lever will lift automatically.

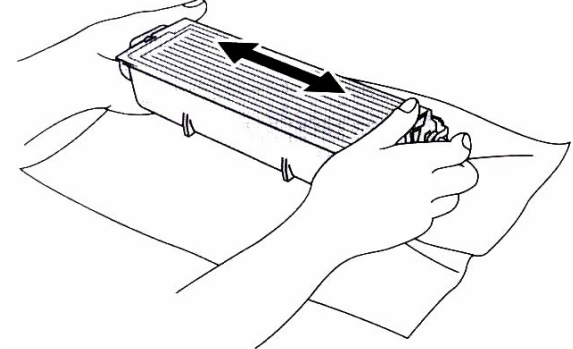
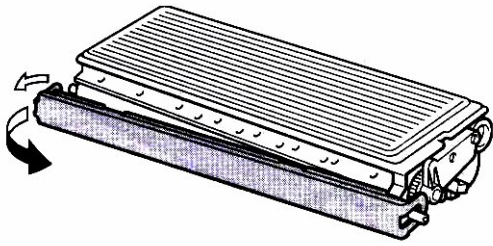
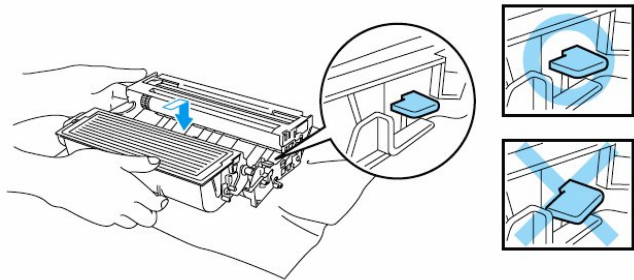
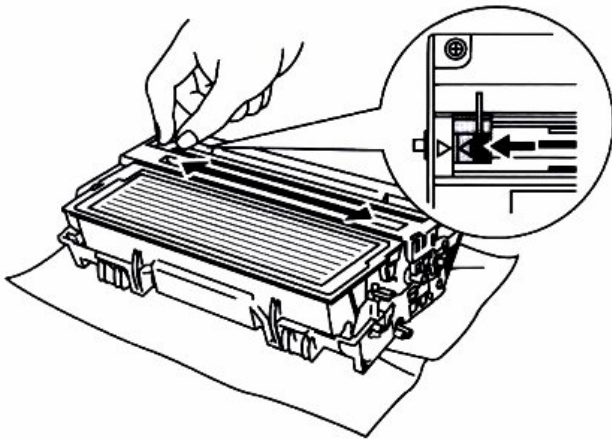

7. Clean the primary corona wire inside the drum unit by gently sliding the blue tab from right to left and left to right several times. Return the tab to the home position (▲) before you put the drum unit back in the printer. If you do not, printed pages may have a vertical stripe.

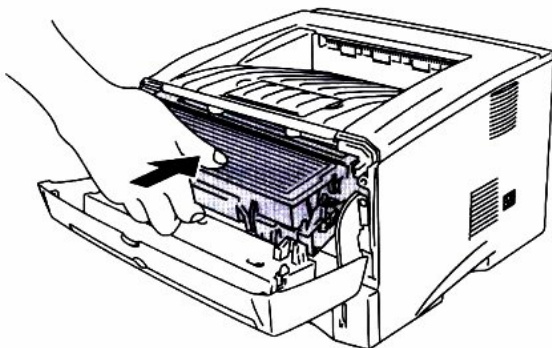

8. Put the drum unit assembly back in the printer. Close the front cover of the printer.